

APPLICANT: Vinings Jubilee Partners, LTD

PETITION No.: V-34

PHONE: 770-438-8080

DATE OF HEARING: 05-09-2018

REPRESENTATIVE: J. Kevin Moore

PRESENT ZONING: NRC, NS

PHONE: 770-429-1499

LAND LOT(S): 908, 909, 952, 953

TITLEHOLDER: Vinings Jubilee Partners, LTD

DISTRICT: 17

PROPERTY LOCATION: On the south and west side of Paces Ferry Road, east of CSX railline, bisected by New Paces Ferry Road, (4300 Paces Ferry Road, 2850 Paces Ferry Road, 2950 New Paces Ferry Road).

SIZE OF TRACT: 9.71 acres

COMMISSION DISTRICT: 2

TYPE OF VARIANCE: 1) Waive the minimum sign setback requirement of 62 feet from the center of an arterial road right-of-way; 2) waive the minimum sign setback requirement of 42 feet from the center of any other road right-of-way; 3) waive the requirement that all ground-based monument-style signage must be located a minimum of one (1) foot from the existing public right-of-way; and 4) waive the requirement for ground based monument style signage to allow the signs depicted in the attached renderings.

OPPOSITION: No. OPPOSED **PETITION No.** **SPOKESMAN**

BOARD OF APPEALS DECISION

APPROVED **MOTION BY**

REJECTED **SECONDED**

HELD **CARRIED**

STIPULATIONS:

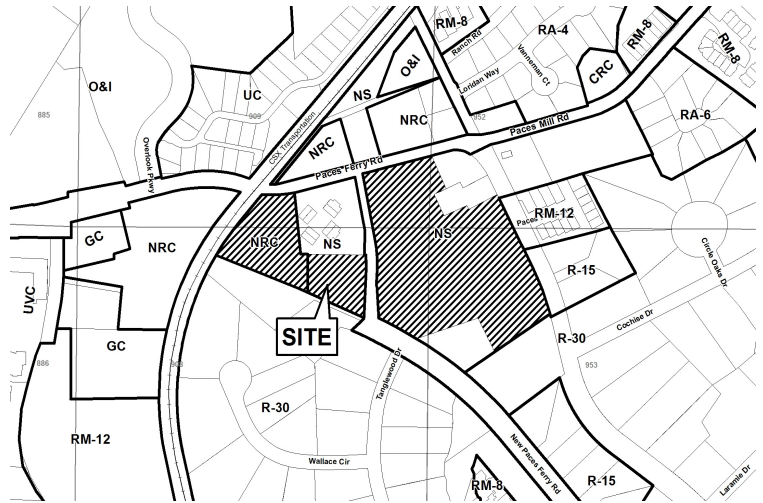

APPLICANT: Vinings Jubilee Partners,
LTD

PETITION No.: V-34

COMMENTS

TRAFFIC: Recommend monument signs be placed off the right-of-way and installed where it will not impede the line of sight for the driveways or roadways.

DEVELOPMENT & INSPECTIONS: No comments.

SITE PLAN REVIEW: No comments.

STORMWATER MANAGEMENT: No comments.

HISTORIC PRESERVATION: No comments.

DESIGN GUIDELINES: No comments.

CEMETERY PRESERVATION: There is no significant impact on the cemetery site listed in the Cobb County Cemetery Preservation Commission's Inventory Listing which is located in this, or adjacent lot.

WATER: Signs may not be placed within County water easements or over County water facilities

SEWER: Signs may not be placed within County water easements or over County water facilities

APPLICANT: Vinings Jubilee Partners,
LTD

PETITION No.: V-34

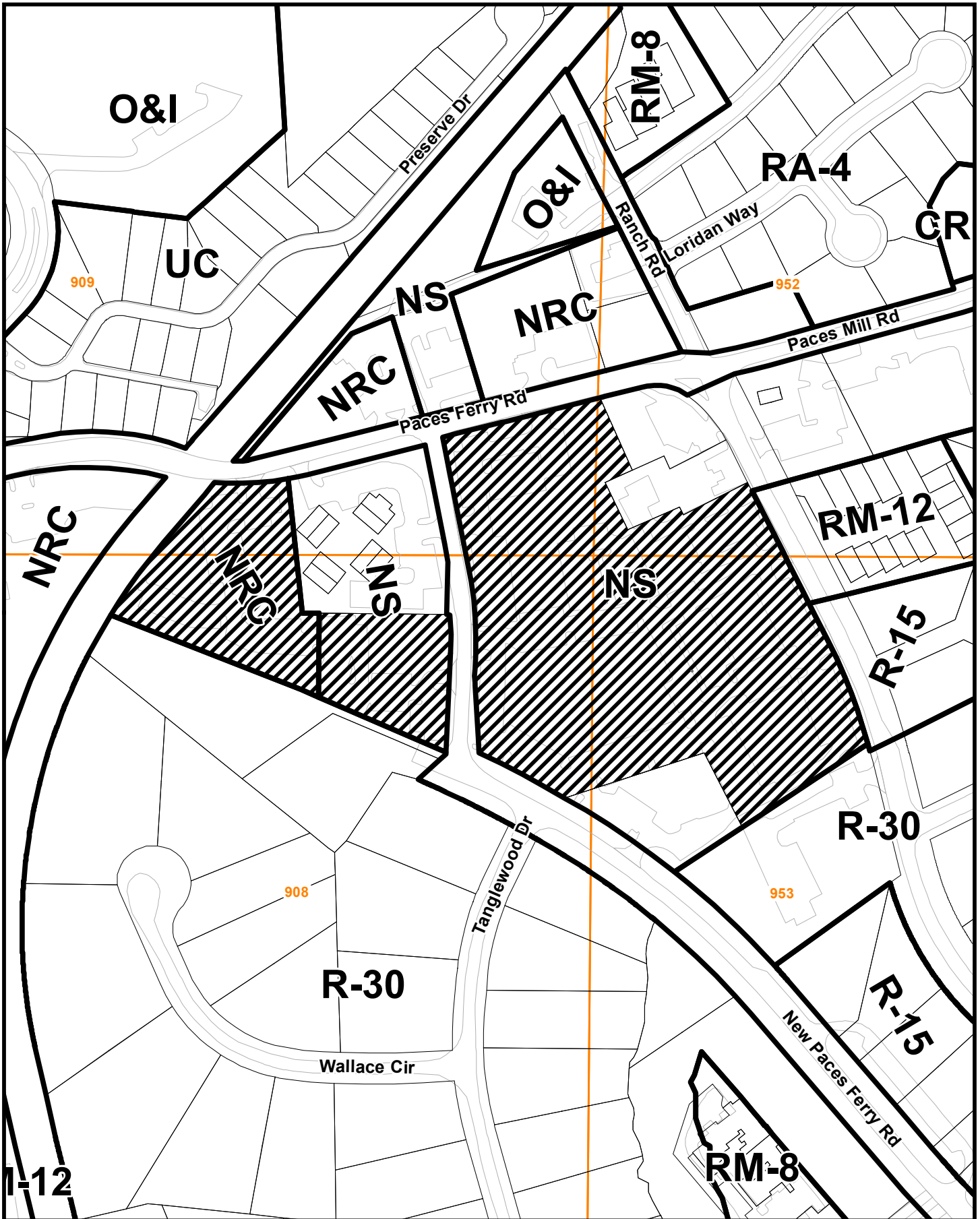

FIRE DEPARTMENT: No comments.

V-34 2018-GIS

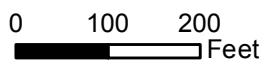

This map is provided for display and planning purposes only. It is not meant to be a legal description.



-  Land Lot
-  City Boundary

RECEIVED
MAR - 8 2018

Application for Variance Cobb County

COBB CO. COMM. DEV. AGENCY
ZONING DIVISION

(type or print clearly)

Application No. V- 34 (2018)
Hearing Date: 05/09/2018

Vinings Jubilee Partners, Ltd.,
Applicant a Georgia limited partnership Phone # (770) 438-8080 E-mail spetters@pacesholdings.com
Moore Ingram Johnson & Steele, LLP Emerson Overlook, Suite 100, 326 Roswell Street
J. Kevin Moore Address Marietta, GA 30060
(representative's name, printed) (street, city, state and zip code)

BY: [Signature] Phone # (770) 429-1499 E-mail jkm@mijis.com
(representative's signature) Georgia Bar No. 519728

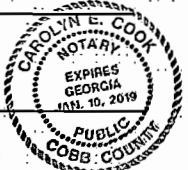

Signed, sealed and delivered in presence of:
Carolyn E. Cook
Notary Public

My commission expires: January 10, 2019

Vinings Jubilee Partners, Ltd.,
Titleholder a Georgia limited partnership Phone # (770) 438-8080 E-mail spetters@pacesholdings.com
Suite 363, 4300 Paces Ferry Road
Signature See Attached Exhibit "A" Address: Atlanta, GA 30339
(attach additional signatures, if needed) (street, city, state and zip code)

Signed, sealed and delivered in presence of:

My commission expires: _____

Notary Public

Present Zoning of Property NS, NRC
Southernly and westerly sides of Paces Ferry Road; easterly and westerly sides of New Paces Ferry Road;
Location Easterly of W. & A. Railroad (4300 Paces Ferry Road; 2850 Paces Ferry Road; 2950 New Paces Ferry Road)
(street address, if applicable; nearest intersection, etc.)

Land Lot(s) 908, 909, 952, 953 District 17th Size of Tract 7.161 +/- (Parcel 1) Acre(s)
9.711 +/- (Overall)

Please select the extraordinary and exceptional condition(s) to the piece of property in question. The condition(s) must be peculiar to the piece of property involved.

Size of Property _____ Shape of Property _____ Topography of Property _____ Other X

Does the property or this request need a second electrical meter? YES _____ NO X

The Cobb County Zoning Ordinance Section 134-94 states that the Cobb County Board of Zoning Appeals must determine that applying the terms of the Zoning Ordinance without the variance would create an unnecessary hardship. Please state what hardship would be created by following the normal terms of the ordinance:
See Exhibit "B" attached hereto and incorporated herein by reference.

List type of variance requested: (1) Waiver of the minimum yard requirement of sixty-two (62) feet from the center of an arterial road right-of-way (See Sec. 134-313(i)(1)); (2) Waiver of the minimum yard requirement of forty-two (42) feet from the center of any other road right-of-way (See Sec. 134-313(i)(1)); and (3) Waiver of the requirement that all ground-based monument-style signage must be located a minimum of one (1) foot from the existing public right-of-way (See Sec. 134-313(i)(2)).

RECEIVED
 MAR - 8 2018
 COBB CO. COMM. DEVELOPMENT
 ZONING DIVISION

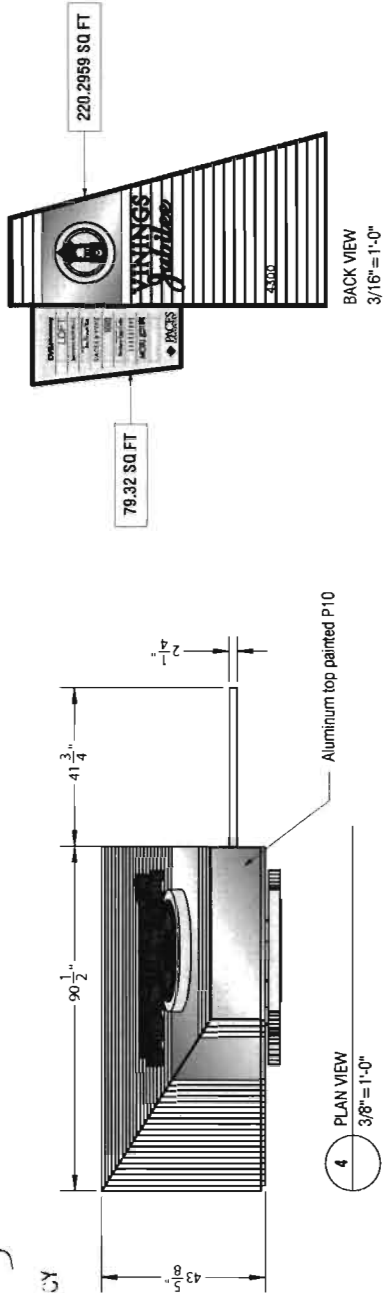

5405 Buford Hwy, Ste. 270
 Norcross, GA 30071
 678.580.3281

These drawings were produced by IMG for the sole purpose of conveying our intended manufacturing process. They are not to be used for any other purpose. The VININGS Jubilee logo and the VININGS Jubilee name are the property of IMG. Permission to copy, reproduce, or otherwise use the VININGS Jubilee logo or name is granted only as indicated through a written contract with IMG.



VININGS JU
 V-34
 (2018)
 Exhibit

SOFT: 3 D
 SR: D
 PM: JA
 SCALE: NOTED
 DATE: 07/20/17
 DSR: GT
 SUBMITTED:
 REVISED:

RELEASED:
 UPDATED
 RELEASE:

SIGN TYPE: A
 PRIMARY ID MONUMENT

FILE LOCATION:
 \\NAS-SSR02\Projects\2018\Signs\Submittals_Vinings_Jubilee_1801_Vinings_Jubilee_18_Arch\Drawings\20 Monument

PAGE
 1.0

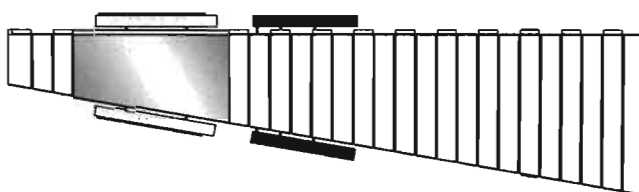
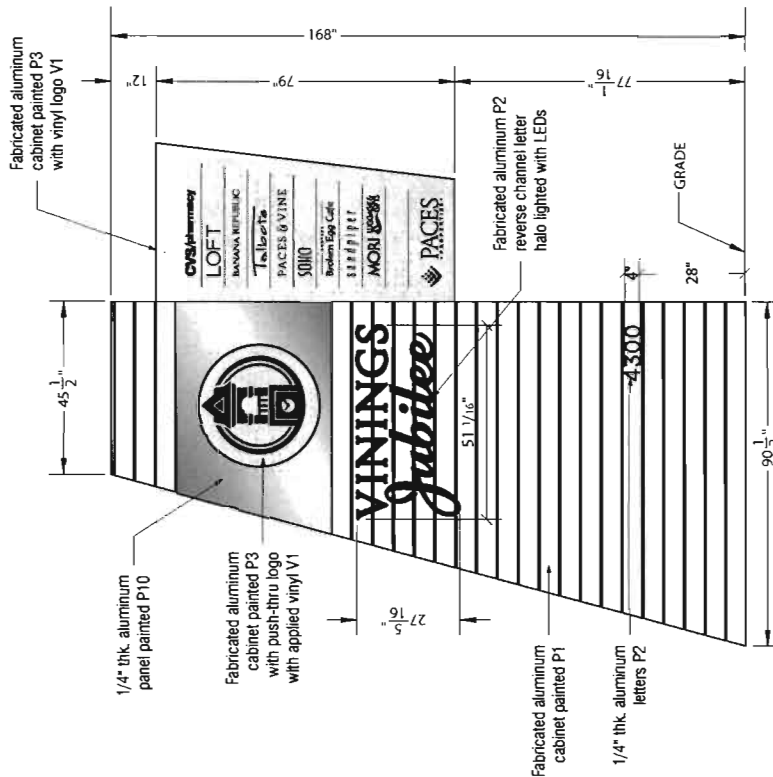
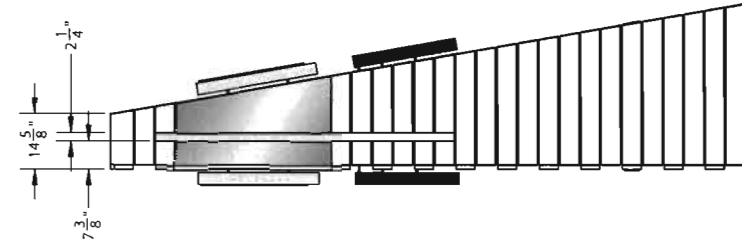
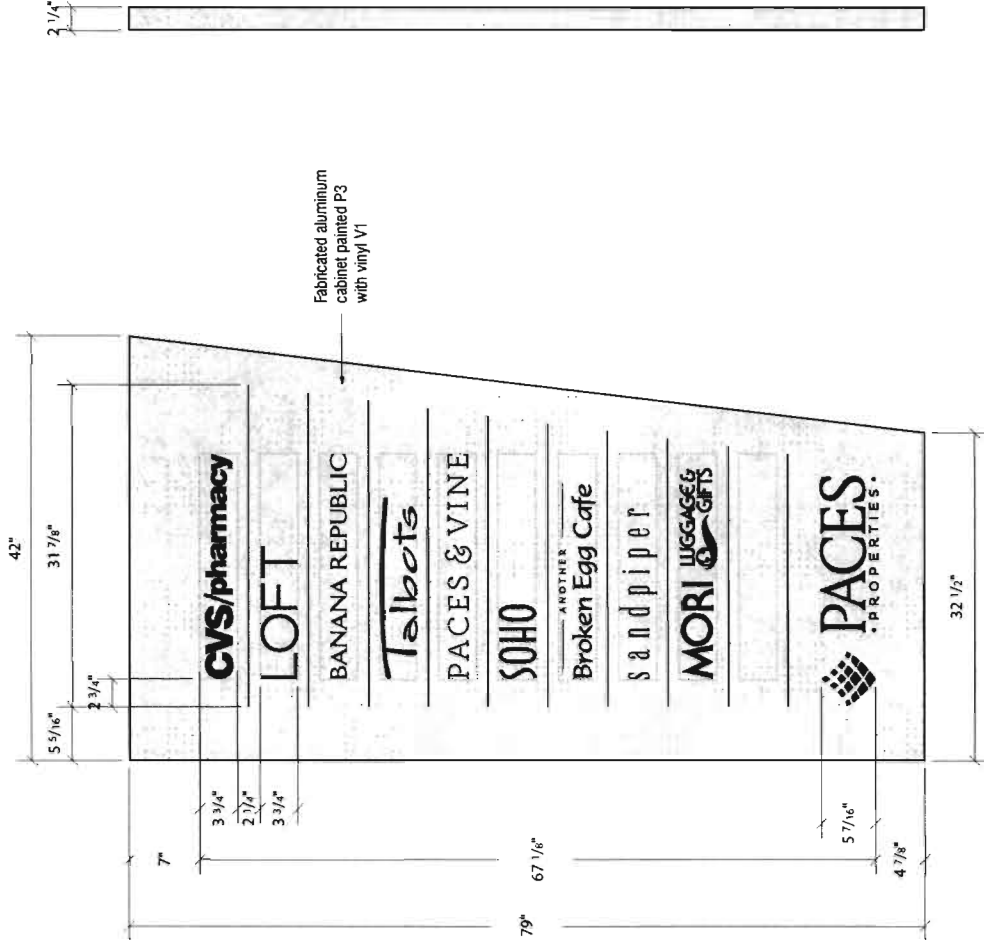

EXHIBIT "1"

RECEIVED
 MAR - 8 2018

COBB CO. COMM. DEV. AGENCY
 ZONING DIVISION



1 FRONT VIEW
 1" = 1'-0"

2 SIDE VIEW
 1" = 1'-0"

3 BACK VIEW
 1" = 1'-0"



5405 Buford Hwy, Ste. 270
 Norcross, GA 30071
 678.580.3281

These drawings were produced by IMG for the sole purpose of conveying our intended manufacturing process to the fabricator. They are not to be used for any other purpose without the written consent of IMG.



VININGS JU

V-34
 (2018)
 Exhibit

SO#: 3

SR: D

PM: JA

SCALE: NOTED

DATE: 07/21/17

DSR: GT

SUBMITTED: 07/21/17

REVISED:

RELEASED:
 UPDATED:
 RELEASE:

SIGN TYPE: A
 PRIMARY ID MONUMENT

FILE LOCATION
 VMS-SERIES: 07/21/17
 2017_Vinings_Jubilee_V-34_Architectural ID Monument

RECEIVED
MAR - 8 2018
COBB CO. COMM. DEV. AGENCY
ZONING DIVISION

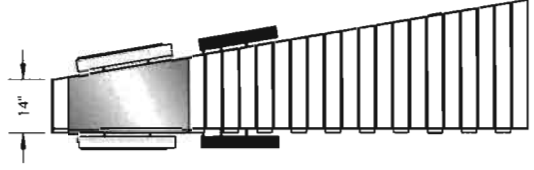
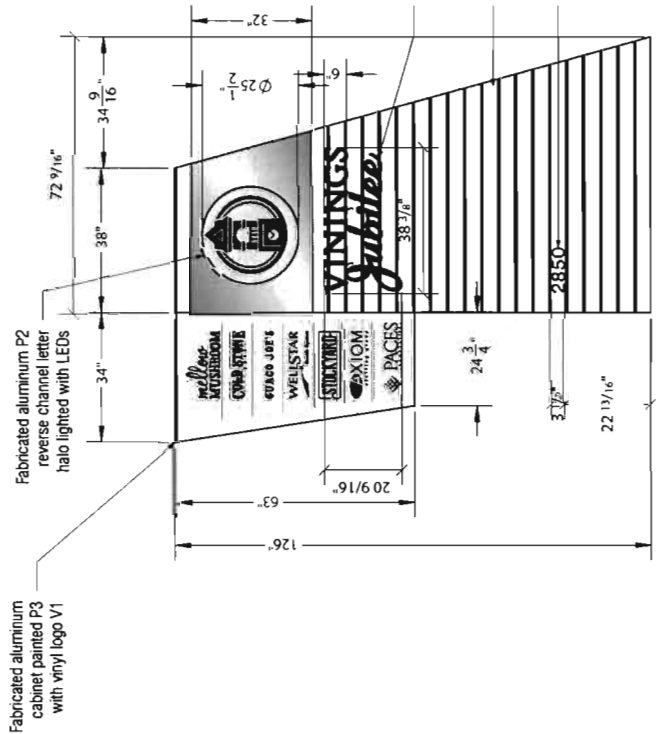
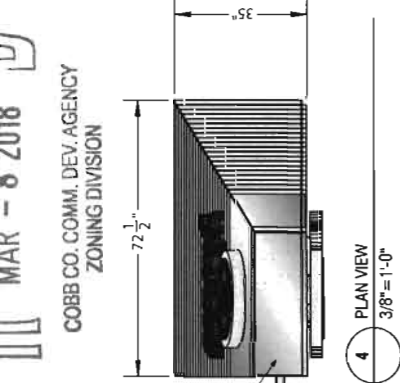
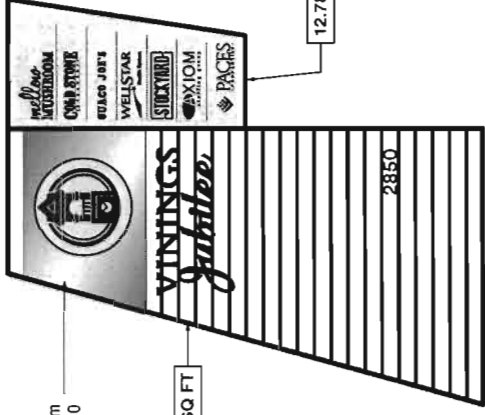

5405 Buford Hwy, Ste. 270
Norcross, GA 30071
678.580.3281

These drawings were produced by IMG for the sole purpose of conveying information and are not to be used for any other purpose without the express written consent of IMG. These manufacturing techniques are the property of IMG and shall remain confidential. No other party is to reproduce or distribute the drawings or any information thereon without consent from IMG.



VININGS JUBILEE

V-34
(2018)
Exhibit

SO: J
SR: D
PM: JA
SCALE: NOTED

DATE: 07/23/17
SUBMITTED: GT
REVIS: GT

DATE: 07/23/17
SUBMITTED: GT
REVIS: GT

RELEASED:
UPDATED
RELEASE:

SIGN TYPE: B.1
SECONDARY ID MONUMENT

RULE LOCATION
VININGS Jubilee (2018) Exhibit
2018_Vinings_Jubilee_2_D_S-Secondary ID Monument

RECEIVED
MAR - 8 2018

COBB CO. COMM. DEV. AGENCY
2 1/4" ZONING DIVISION

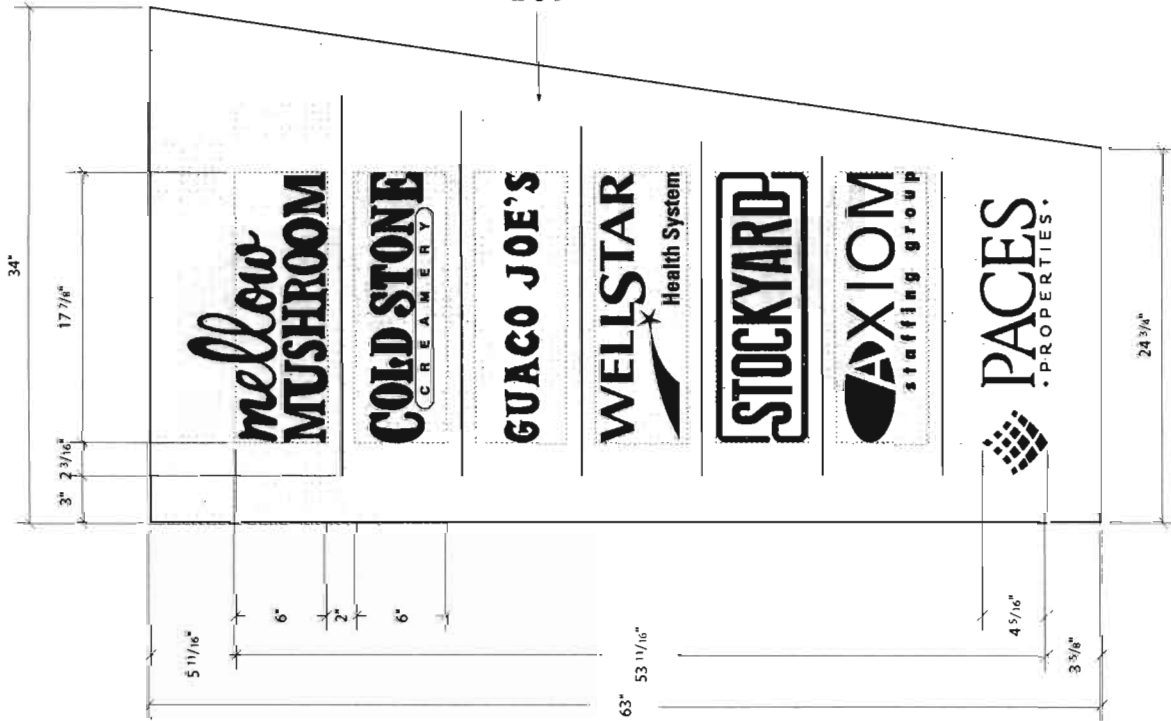

1 FRONT VIEW
1-1/2" = 1'-0"

2 SIDE VIEW
1-1/2" = 1'-0"

3 BACK VIEW
1-1/2" = 1'-0"



5405 Buford Hwy., Ste. 270
Norcross, GA 30071
678.580.3281

These drawings were produced by IMG for the sole purpose of conveying our intended manufacturing process to the contractor. They are not to be used for any other purpose without the express written consent of IMG. Permission to copy, distribute to others or otherwise use these drawings in any form without the written consent of IMG.



VININGS JU
V-34
(2018)
Exhibit

SO: 3
SR: D
PK: JA
SCALE: NOTED
DATE: 07/21/17
SUBMITTED: 07/21/17
REVIS: GT
DSR: GT

RELEASED:
UPDATED:
RELEASE:

SIGN TYPE: B.1
SECONDARY ID MONUMENT

FILE LOCATION:
\\img-servers\img\Projects\2018_Vinings_Jubilee\2_Bid\Secondary ID Monument

RECEIVED
MAR - 8 2018

COBIB CO. COMM. DEV. AGENCY
ZONING DIVISION

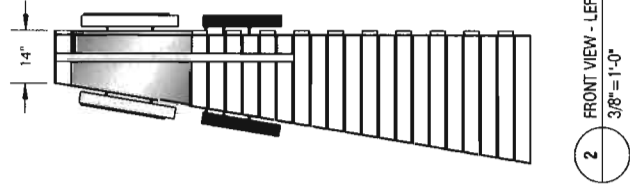
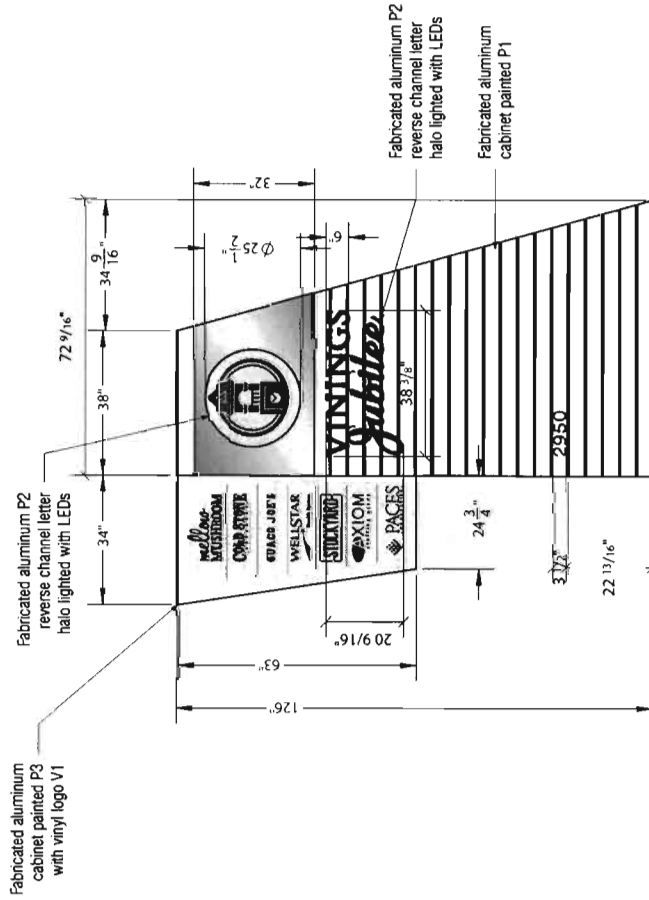
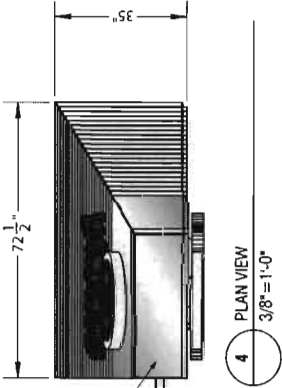
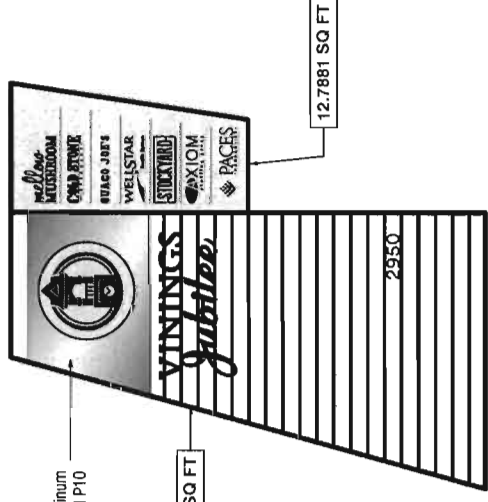

5405 Buford Hwy., Ste. 270
Norcross, GA 30071
678.580.3281

These drawings were produced by IMG for the sole purpose of conveying our standard manufacturing process to the fabricator. They are not to be used for any other purpose without the express written consent of IMG. Permission to copy, distribute, or otherwise use these drawings without their consent through a third party is prohibited.



VININGS JU
V-34
(2018)
Exhibit

SO#: 36 DE
SR: JA
PM: JA
SCALE: NOTED
DATE: 07/21/17
SUBMITTED: DSR: GT
REVISED: RE: GT

RELEASED:
UPDATED:
RELEASE:

SIGN TYPE: B.2
SECONDARY ID MONUMENT

FILE LOCATION:
\\img-scr1\img\Projects\2018_Vinings_Jubilee\2018_Vinings_Jubilee\2018_Vinings_Jubilee\Secondary ID Monument

RECEIVED
 MAR - 8 2018

COBB CO. COMM. DEV. AGENCY
 ZONING DIVISION

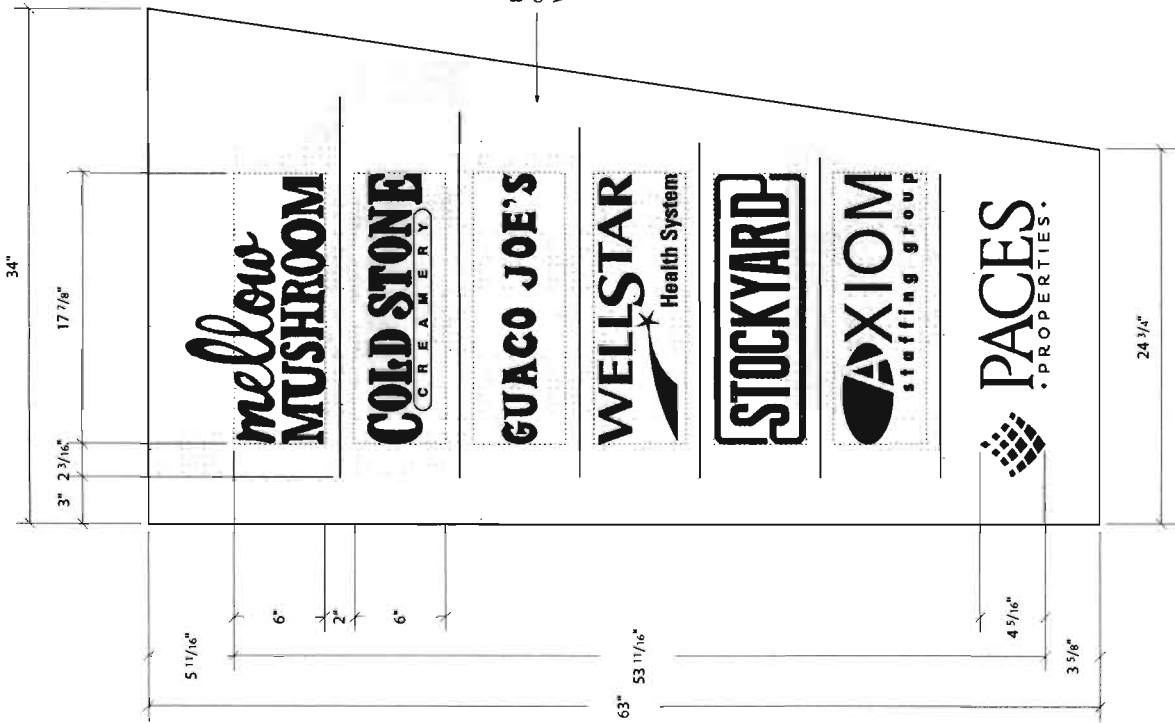

1 FRONT VIEW
 1-1/2" = 1'-0"

2 SIDE VIEW
 1-1/2" = 1'-0"

3 BACK VIEW
 1-1/2" = 1'-0"



5405 Buford Hwy, Ste. 270
 Norcross, GA 30071
 678.580.3281

These drawings were produced by IMG for the sole purpose of conveying our intended manufacturing process. They are not to be used for any other purpose. These manufacturing techniques are the property of IMG. No part of this drawing is to be reproduced, stored in a retrieval system, or transmitted in any form or by any means, electronic, mechanical, photocopying, recording, or by any information storage and retrieval system, without consent from IMG.



VININGS JU
 V-34
 (2018)
 Exhibit

SOP: 3
 SR: D
 P#: JA
 SCALE: NOTED
 DATE: 07/23/17
 DSR: GT
 SUBMITTED: 07/23/17
 REVISED:

RELEASED:
 UPDATED
 RELEASE:

SIGN TYPE: B.2
 SECONDARY ID MONUMENT

FILE LOCATION:
 \\MG-SRVE1\Engineering\2018\Sublet
 2018_Vinings_Jubilee\2.0_B_Secondary ID Monument

PAGE
 2.3

RECEIVED
MAR - 8 2018

COBB CO. COMM. DEV. AGENCY
ZONING DIVISION

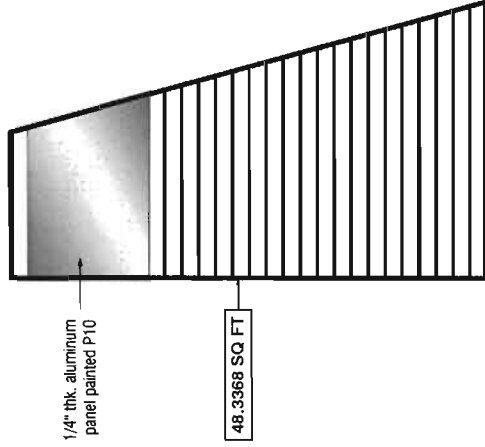

4 BACK VIEW
3/8" = 1'-0"

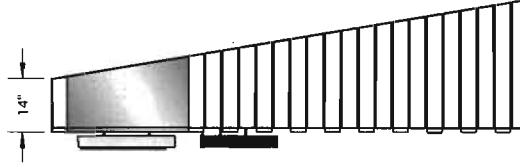

3 FRONT VIEW - RIGHT
3/8" = 1'-0"

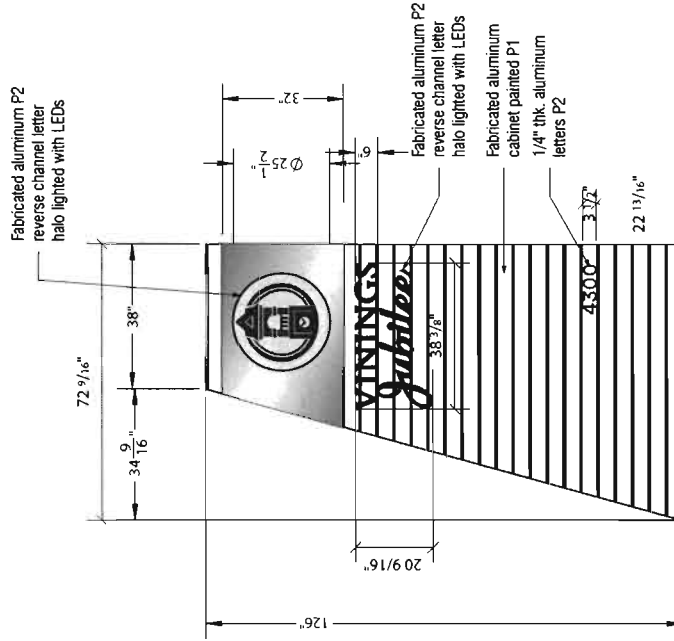

1 FRONT VIEW
3/8" = 1'-0"

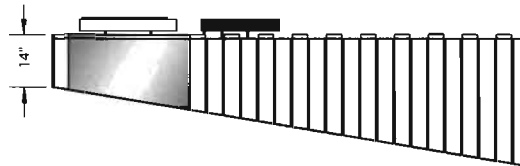

2 FRONT VIEW - LEFT
3/8" = 1'-0"



5405 Buford Hwy., Ste. 270
Norcross, GA 30071
678.580.3281

These drawings were produced by IMG for the sole purpose of conveying our intended manufacturing intent. They are not to be used for construction. These manufacturing techniques are the property of IMG. Permission to copy, reproduce or otherwise use these drawings without the written consent of IMG.



VININGS
Jubilee

VININGS JU
V-34
(2018)
Exhibit

SO: 3
DR: D
PK: JA
SCALE: NOTED
DATE: 07/21/17
DSR: GT
SUBMITTED: 07/21/17
REVISED:

RELEASED:
UPDATED
RELEASE:

SIGN TYPE: B.3
SECONDARY ID MONUMENT

FILE LOCATION
\\NAS-SERVER\Engineering\2018\New\Jubilee\2018_Vinings_Jubilee_0_B-Secondary ID Monument

V-34
(2018)
Exhibit

EXHIBIT "A" - ATTACHMENT TO APPLICATION FOR VARIANCE

RECEIVED
MAR - 8 2018

COBB CO. COMM. DEV. AGENCY
ZONING DIVISION

Application No.: V- 34 (2018)
Hearing Date: May 9, 2018

Applicant/Titleholder: **Vinings Jubilee Partners, Ltd.,
a Georgia limited partnership**

VININGS JUBILEE PARTNERS, LTD.,
a Georgia limited partnership

BY: DFP, INC., a Georgia corporation
its General Partner

BY: George A. Pettus
TITLE: President

[Corporate Seal]

Printed Name: George A. Pettus

Date Executed: MAR 7 '18

Address: Suite 363, 4300 Paces Ferry Road
Atlanta, Georgia 30339

Telephone No.: (770) 438-8080

Signed, sealed, and delivered
in the presence of:

Karen Adele Harvill
Notary Public

Commission Expires

(Notary Seal)

KAREN ADELE HARVILL
MY COMMISSION EXPIRES
JUNE 13 2018
COBB COUNTY, GA.
NOTARY PUBLIC

V-34
(2018)
Exhibit

EXHIBIT "B" - ATTACHMENT TO APPLICATION FOR VARIANCE

RECEIVED
MAR - 8 2018

Application No.: V- 34 (2018)
Hearing Date: May 9, 2018

COBB CO. COMM. DEV. AGENCY
ZONING DIVISION

BEFORE THE COBB COUNTY BOARD OF ZONING APPEALS

**Applicant/Titleholder: Vinings Jubilee Partners, Ltd.,
a Georgia limited partnership**

Please state what hardship would be created by following the normal terms of the ordinance:

Vinings Jubilee Partners, Ltd., as Applicant and Titleholder (hereinafter collectively "Applicant"), is the owner of improved real property totaling 9.711 acres, more or less, located on the southerly and westerly sides of Paces Ferry Road; the easterly and westerly sides of New Paces Ferry Road; easterly of the W. & A. Railroad, being more particularly known as 4300 Paces Ferry Road, 2850 Paces Ferry Road, and 2950 New Paces Ferry Road, Land Lots 908, 909, 952, and 953, 17th District, 2nd Section, Cobb County, Georgia (hereinafter the "Property" or "Subject Property"). The Property was developed many years ago for the retail center known as "Vinings Jubilee," which is still operational and a key component to the Vinings restaurant and retail area along Paces Ferry Road.

Applicant is proposing to upgrade and completely replace the existing signage for the Vinings Jubilee retail center. Copies of the proposed replacement signage plans are attached collectively as Exhibit "1" to this narrative. Applicant seeks waivers of certain regulations within the Sign Ordinance, as follows:

- (1) Waiver of the minimum yard requirement of sixty-two (62) feet from the center of an arterial road right-of-way;
- (2) Waiver of the minimum yard requirement of forty-two (42) feet from the center of any other road right-of-way; and
- (3) Waiver of the requirement that all ground-based monument-style signage must be located a minimum of one (1) foot from the existing public right-of-way.

Applicant proposes the installation of the new, replacement signage in the exact location as the existing signage, and the current requirements of the Cobb County Sign Ordinance would not allow replacement of the signs. There are no other reasonable locations for placement of the new and updated signage due to the

existing infrastructure and improvements within the Vinings Jubilee retail center than where they are presently located. Additionally, in the years following construction and occupancy of the retail center, the Vinings area has experienced immense growth which has necessitated improvements along the existing rights-of-way, including condemnations of properties for road widenings, construction of new roadways, entrance realignments, and many other improvements which directly affected the Subject Property. Further, the Cobb County Zoning Ordinance and Development Standards which was in effect at the time of development of the retail center have been revised. The waivers as set forth above, must be approved to allow for installation of the updated, replacement signage. To grant the requested variances would result in no detrimental impact upon the Subject Property or any other adjacent or surrounding properties.